

Composite Action in RCC and Brick Masonry

Praveena Rao and Dr.B.Jena

ABSTRACT- In a wall with openings lintels are built, thus the load carried by lintels is transferred of the masonry in jambs. Lintel with masonry above is a complex phenomenon known as the composite action. In this experimental work, the contribution of the brick masonry towards the load carrying capacity of the lintel is analysed in the composite action thus developed. Six specimens of sections (3 inches) 75 mm thick and (10 inches) 250 mm wide R.C. lintels with 4 Nos. of 10mm diameter bars are provided for spanning openings of 4 feet and 6 feet. Shear reinforcement comprising ties (90° bent) of 8mm diameter bars are provided at regular intervals throughout the span. These lintel-masonry test walls were tested to failure under flexure in the beam testing frame and their load-deflection curves were plotted. The failure mechanism and the cracking pattern of the specimen were identified as a major diagonal shear crack. The shear strength and the moment capacity of the specimens were calculated and compared with the test results. The shear strength of the lintel-masonry specimens were calculated by adopting the methods by the British codes for deep beams. Secondly, the empirical formula given by the Indian codes (IS 456:2000) for shear strength of beams without shear reinforcement was modified and adopted taking into account the compressive strength of masonry.

A relationship between the masonry units, mortar and masonry blocks given by a relation by A.W.Hendry et.al was adopted. Samples of masonry unit were tested in the 40 tonne UTM for the crushing strength of bricks when tested on the flat surface, on the side and the top edge of the bricks.

The basic objective of the work is to find the contribution of brick masonry towards the strength of the lintel in carrying the load above the openings in walls and thus acting as a structural member. Thus an alternative method of designing economic lintel sections can be adopted.

Index Terms- Composite action, brick masonry, load-deflection curves, RCC lintel, strength, shear failure.

1. INTRODUCTION

Composite action of lintel with masonry is a complex phenomenon and is governed by a number of parameters. In a simply supported wall-beam the load acting introduces tensile forces in the beam and the arching action which creates a horizontal thrust at each abutment.

In general, the stiffer the beam the greater the beam-bending moment since a larger proportion of the load will be transmitted to the beam. Composite action cannot be achieved unless there is sufficient bond between the wall and the beam to allow for the development of the required shearing forces. The large compressive stresses near the supports result in large frictional forces along the interface of wall and lintel. The following are the major factors affecting it: (a) Bond/friction at the interface of lintel and masonry, (b) Crushing strength of masonry, (c) Shear strength of masonry, (d) Masonry bond, (e) Height of masonry above lintel, (f) Reinforcement in lintel, and (g) Whether the masonry is already stressed to limit or not.

2. LITERATURE REVIEW

Vermeltfoort and Schijndel [1] have made an attempt to assign material properties like shear strength and modulus of elasticity randomly. They had experimentally tested the behaviour of a masonry wall with a prefabricated concrete lintel and simulated using COMSOL. With the help of COMSOL, they have modelled the lintel-masonry interaction, including the variation of mechanical properties over the volume of the

specimen. Three series of three lintel-wall combinations were experimentally tested to failure, where the main parameter was the support condition. The test walls had a span of 2.8 meters; their height was 60mm for the lintel with nine layers of masonry on top were tested with four point bending test. The load at which the first crack appeared and the ultimate load was observed and verified after testing by observing load deformation graphs.

Studies carried out at the Central Building Research Institute(Roorkee) [2] on thin precast R.C.C. lintels in brick walls during 1964-65 has also shown that they act together, tension being taken by the lintel and compression by the brickwork. Based on these studies, 7.5 cm thick and 23 cm wide precast R.C. lintels with 3 Nos. 10 mm diameter mild steel bars as main reinforcement were recommended for spanning openings up to 1.8 m. provided the bricks used have minimum compressive strength of 10 N/mm², the mortar is not leaner than 1:6 cement: sand mortar and height of masonry above the lintel is at least 45 cm. Twelve lintel masonry panels were made and tested. Uniformly distributed load was applied in stages on the panels. The strains, deflections and development of cracks were noted at each stage of loading, till the panels failed. Masonry cubes made along with the panels were also tested in a 100 tonnes capacity Universal Testing Machine to determine the stress-strain relationship for the stresses in the masonry panels for corresponding strains. The stress developed in the reinforcement even at the failure stage was found to be less than the permissible stress in steel. This indicates that a major portion of the load is transferred to the supports by arch action developed in the brickwork. The ultimate

load increased with the height of brickwork. For the same height, the load carrying capacity decreased with masonry strength.

Hossain and Ali, have presented a linear elastic finite element analysis of composite action between masonry wall made from clay solid bricks and RCC supporting beam. Isoparametric four noded rectangular element with two degrees of freedom at each node was used in this analysis. Initially the wall was considered as a homogenous continuum when coarse mesh was used in element discretization. Finally, non-homogeneity of the masonry and concrete was incorporated in the model by discretising the bricks, mortar joints, steel reinforcement and the concrete separately along with their individual material properties. They found that due to arch action, major portion of the distributed load applied at the top of the wall concentrates on a small portion of the beam near the supports. There is a very large reduction of bending moment in the supporting beam due to the composite action of wall-beam structure. Although the load on the top of the wall is uniformly distributed over the entire span, due to composite action the maximum moment in the beam does not occur at the middle of the span. This change of location of maximum bending moment in the supporting beam is observed by previous investigators. In this study the maximum moment in the supporting beam is $0.018 wL^2$ and is found to occur at a distance of $0.14 L$ from the end of the support. The maximum moment in a simply supported due to uniformly distributed load is given by $WL^2 / 8$ which occurs at the mid span. But if, composite action of wall and supporting beam is considered the moment at middle section of beam is obtained as $0.012 wL^2$, which is $1/10^{\text{th}}$ of the value obtained from conventional formula.

3. MATERIALS

Cement used in the experiments was Portland Slag Cement (PSC) conforming to IS 455-1989.

The aggregates are categorized into fine aggregates (particle size between 0.075mm and 4.75mm) and coarse aggregate (particle size larger than 4.75mm). Sand taken from river beds and pits is normally used as fine aggregate, while gravel and crushed rock are normally used as coarse aggregate. Crushed granite of 12.5mm & 20mm size are used as coarse aggregate, the sieve analysis of aggregates confirms to the specifications of IS: 383-1970 as well as fine aggregates were used which satisfied the required properties for experimental work and conforms to zone as per the specification of IS: 383-1970.

Longitudinal reinforcement consisted of four bars through of grade Fe500 throughout the span of 10mm diameter along with ties of 8mm diameter equally spaced. A tension test was conducted on the specimen of 1 meter length cut from the bars used in the fabrication

and casting of the lintels. Three specimens were tested in UTM (40 tonnes capacity) and the average of the ultimate strength of the three is considered.

The masonry was laid above the lintel specimens with burnt clay bricks conforming to IS 1077:1992. The bricks were tested for the compressive strength as specified in IS 3495(part1): 1992. The bricks were acquired from the same manufacturer for all the specimens tested to maintain uniformity of the properties of bricks used. The dimension of the bricks was (10 x 4.5 x 3) inches and the percentage of water absorption was found to be 14% by weight of the bricks when immersed in water for a period of 24 hours.

4. EXPERIMENTAL PROGRAM

4.1 Design and Detailing Of Lintel:

Lintel specimens spanning 4 feet were constructed with a depth of 3 inches (76.2 mm) and a width of 10 inches (254 mm). The reinforcing bars of 10mm diameter (4 nos.) were cut and tied with distribution bars of 8mm diameter (8 nos.) with the help of G.I. wires. The main bars were equally spaced allowing a 1 inch cover for the reinforcement.

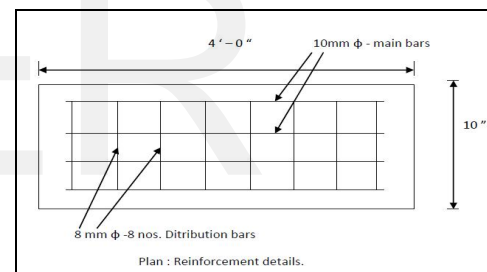

Fig.4.1 Detailing of lintel.

Ties were bent at 90° as specified in SP 16 Handbook for Reinforced concrete design and provided throughout the span at 170 mm centre to centre. The reinforcement mesh was placed in the centre of the thickness of the lintel.

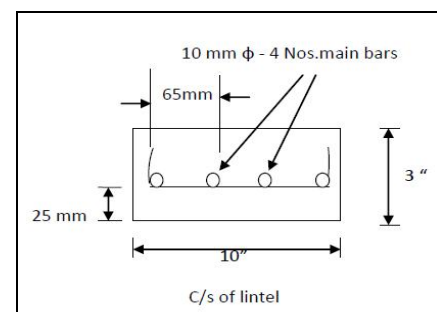

Fig.4.2. Sectional view of lintel.

A nominal mix proportion of 1:2:4 and a water / cement ratio of 0.45 was selected which measured a slump value of 70mm. The amount of cement, sand, coarse aggregates required for cubes, were weighed. The materials were first dry mixed then mixed with 1/3rd amount of total

water. Slump test is conducted to measure the degree of workability of mix. The cement, sand (F.A.) and coarse aggregates (C.A.) were thoroughly mixed in the required 1:2:4 mix proportion in a concrete pan / paddle mixer. Uniform mixing of concrete should be ensured to get correct test results of the specimen. After mixing, concrete was placed in the beam mould in layers of a depth equal to approximately 1 inch. Each layer was manually compacted using ½ inch steel rod to eliminate voids in the specimen. The lintel was de-moulded after a period of 24 hours and kept on gunny bag curing for two weeks.



Fig. 4.3. Reinforcement in beam mould during casting.

Concrete cubes were casted with the same batch of mixed concrete which represent the compressive strength of the concrete incorporated in the lintel specimens. The cubes were casted similarly in the moulds of dimensions 15 cm x 15 cm x 15 cm and well compacted to eliminate voids. Moulds were safely removed after 24 hours causing no damage to the specimen and immediately concrete cube specimens were kept in curing tank, completely immersed in for curing. Cylindrical concrete specimens were casted in moulds of 30 cm height and 15 cm diameter. The steel cylinder moulds were coated with oil on their inner surfaces. The cylinders were filled in three lifts each consolidated 25 blows, representing the concrete incorporated in the test specimen. The concrete cylinders were water cured and tested for split tensile strength test.

4.2 Lintel-Wall Test Panels (Brick Masonry):

As soon as the lintels were de-moulded after 24 hours of casting, they were kept on supports and masonry was laid on top of the lintels. Three specimens were constructed of 4, 6 and 8 layers of masonry for a span of 4 feet in *English bond* as specified in IS 2212:1991. Subsequently, two other specimens were constructed with 8 layers masonry for a span of 6 feet. The method of laying the bricks was followed as specified in the Indian codes. The thickness of joints was maintained at 12mm. The properly filled joints ensure maximum strength and resistance to penetration of moisture which takes place mainly through joints. A mortar of mix ratio 1:6 (cement: sand) was used for the masonry construction and mortar cubes of (70.6 x 70.6 x 70.6)mm were casted from the same batch of mortar used for masonry for its 28 days

compressive strength. Mortar for masonry shall be prepared in accordance with IS 2250: 1981.

4.3 Brick Masonry Blocks:

Masonry blocks were casted of three layers consisting of two bricks in each layer with mortar joints of 12mm thickness. The bricks were laid in the same manner as in the lintel-masonry test wall i.e., each consecutive layer consisting of bricks in header and stretcher alternatively as in *English bond*. The dimension of the masonry block was (25 x 25 x 26) cm inclusive of the mortar joints. The masonry blocks were casted and after a period of 24 hours it was kept in the curing chamber for 28 days curing. Three specimens of masonry blocks were casted and tested for its compressive strength in the Universal Testing Machine 40 tonne capacity.

5. TESTING OF SPECIMENS:

5.1 Experimental equipments and procedure:

Loading Apparatus- Concentrated load was applied by means of a system of hydraulic jack under the beam-testing frame. The specimen is mounted on the stands with simply supported end conditions on rollers. The load is applied with the help of the hydraulic jack and transmitted to the specimen which is displayed by the Proving Ring (20 tonne capacity) in terms of deflection.

The deflection in the proving ring is noted at each increment of the applied load and the corresponding load in kilo Newton transmitted to the specimen can be obtained from the calibration graph of the proving ring. The calibration graph is obtained by testing the proving ring in the Universal Testing Machine 40 tonne capacity. At each applied load in the UTM its corresponding deflection shown in the proving ring is noted. Thus the calibration graph can be obtained by plotting the load applied in kilo Newton against the deflection in the proving ring.

Deflection instrumentation-Dial gauges with the smallest division of 0.01mm were used to measure the mid-span deflections of the specimens. The dial gauge was mounted on the stand at the mid-span and the fixed to its magnetic base. The maximum deflections at the mid-span were recorded for each specimen under the concentrated load applied at mid-span. Deflection of a beam is the displacement of a point on the neutral surface of a beam from its original position under the action of applied loads.

Test procedure - Load was applied in increments until the beam either completely collapsed or the resistance of the beam decreased with increasing deformation. At each load increment all deflection readings were recorded and the crack pattern was observed through a low power

illuminated magnifying glass and marked with ink. Before the next increment of load was applied, the load and deflections were again recorded as a certain amount of load drop-off and deflection increase during the recording period was observed. After yielding and up to failure, loads and deflections were recorded for increments of mid-span deflection rather than load. At various points throughout the test and afterwards, pictures were taken to allow the crack patterns. The control specimens were tested on completion of the lintel-masonry panel test.

5. TESTS ON BRICKS:

5.1 Crushing Strength of Bricks

The Universal testing machine 40 tonne capacity (compression) was used to test the crushing strength of the brick specimens placed on its flat surface, side and on the edge as specified in IS 3495(Part 1): 1992.

Placing the specimens with flat faces horizontal, and mortar filled face facing upwards between two 3-ply plywood sheets each of 3 mm thickness and carefully centred between plates of the testing machine. Apply load axially at a uniform rate of 14 N/mm per minute till failure occurs and note the maximum load at failure. The load at failure shall be the maximum load at which the specimen fails to produce any further increase in the indicator reading on the testing machine.

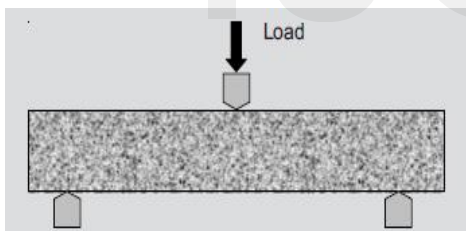

(b) Loading of brick on flat.

5.2 Flexural Tensile Strength of Bricks:

The flexure test method measures behaviour of materials subjected to simple beam loading. Flexural strength is defined as the maximum stress in the outermost fibre. This is calculated at the surface of the specimen on the convex or tension side. Modulus of rupture is defined as the normal tensile stress in concrete, when cracking occurs in flexure test (IS 516-1599). This tensile stress is the flexural strength of concrete and is calculated by the use of the formula, which assumes that the section is homogeneous.

$$\frac{M}{I} = \frac{\sigma}{y}$$

5.3 Compressive Strength of Masonry:

Masonry blocks of dimension 25cm x 25cm x 26 cm were casted and tested in the Universal Testing Machine 40 tonne capacity for the compressive strength of masonry at 28 days. The masonry blocks were made of three layers consisting of two bricks in each layer with mortar bed. Alternate layers consisted of bricks in stretchers and header similar to English bond as in the lintel- masonry test specimens.



Fig. 5.3. Compression test of brick masonry blocks in UTM 40 tonne capacity.

The specimens were kept in the curing chamber for a period of 28 days and air dried for 24 hours before testing. The masonry blocks were casted on the same day as the lintel- wall panels with the same batch of mortar mixed for the specimens. The strength of masonry varies significantly over the strength of the individuals bricks thus the strength of masonry blocks is determined.

It is observed by research work that the masonry strength in compression is smaller than the nominal compressive strength of the units by approximately 70% of compressive strength of bricks. The masonry strength may greatly exceed the cube crushing strength of the mortar used.

6. RESULTS AND DISCUSSIONS

6.1 Brick Crushing Strength Test:

Table 6.1. Brick crushing strength on flat, side and edge.

Serial No.	Surface	Peak Load (kN)	Peak Stress (N/mm ²)	Average Stress (N/mm ²)
1	Flat	193.37	7.032	
2	Flat	212.84	7.735	7.148
3	Flat	192.17	6.680	
4	Side	48.37	2.579	
5	Side	44.77	2.387	2.467

6	Side	45.57	2.436	
7	End	20.57	2.385	
8	End	19.27	2.234	2.185
9	End	15.97	1.936	

Thus, it is observed that the crushing strength of brick is found to be the maximum, when tested on the flat surface. Where as it is the minimum when loaded on the top with a reduction of about 70%.

6.2 Brick Masonry Block Compression Test:

Table 6.2. Compressive strength of masonry blocks.

Serial No.	Dimension(cm)	Wt (kg)	Peak Load (kN)	Peak Stress (N/mm ²)
1	24.5 x 24.5 x 26	29.9	97.6	1.626
2	25 x 25 x 26	30.3	124.6	1.99
3	24.5 x 24 x 27	32.2	135.2	2.29
			Avg Stress =	1.968

It can be observed from the above two tests carried out, that the compressive strength of individual units of masonry is about 80% higher than the compressive strength of a block of masonry. It can be concluded that the reduction in strength is majorly due the occurrence of joints in masonry blocks which act as the weak zones of failure.

6.3 Brick Flexural Tensile Strength Test:

Table 6.3. Flexural tensile strength of brick on flat and side.

Sl	Wt (kg)	Dimension (cm)	Surface	Peak Load (kN)	Stress (N/m ²)	Average Stress (N/mm ²)
1	3.034	26 x 11.5 x 7	Flat	2.2	2.46	
2	3.52	25 x 11.5 x 7	Flat	2.2	2.34	2.46
3	3.257	26 x 11 x 7	Flat	2.2	2.57	
4	3.309	26 x 11.5 x 7.5	Side	3.3	2.096	
5	3.105	25 x 10.5 x 7.5	Side	3.3	2.39	2.54
6	3.454	26 x 11.5 x 7	Side	4.5	3.06	

6.4 Mortar (1:6) Cubes Compressive Strength Test:

Table6. 4. Compressive strength of Mortar cubes.

Serial No.	Weight (kg)	Peak Load (kN)	Peak Stress (N/mm ²)
1	2.119	84.1	8.41
2	2.104	101.7	10.17
3	2.105	101.7	10.17
4	1.979	65.4	6.54
5	2.103	100.2	10.02
		Average Stress =	9.062

6.5 Lintel 4-Foot Span Test:

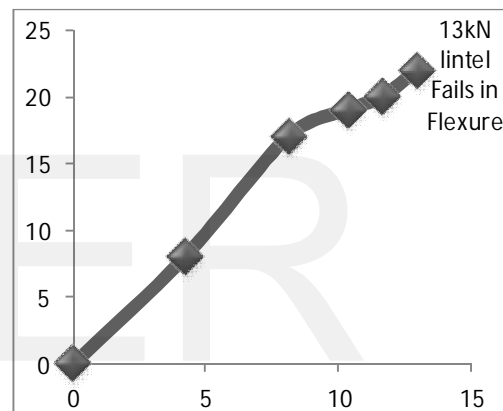

Figure 6.1. Load-deflection curve.

6.6 Lintel-Masonry Test Wall 4-Foot Span (4 Layer Masonry):



Figure 6.2.(a) Load-deflection curve ,(b) Lintel-Masonry Test Wall 4-Foot Span (4Layer Masonry) under concentrated loading

6.7 Lintel-Masonry Test Wall 4-Foot Span (6 Layer Masonry):

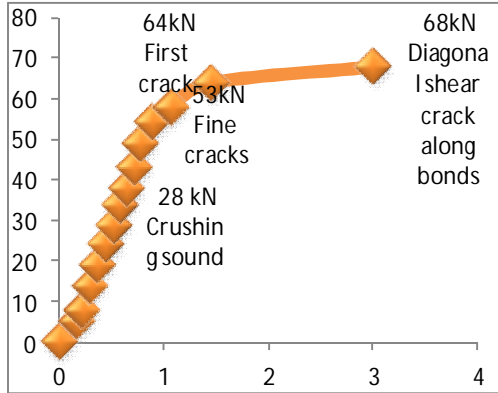

Figure 6.4.(a) Load-deflection curve ,(b) Lintel-Masonry Test Wall 4-Foot Span (8Layer Masonry) under concentrated loading.



Figure 6.3.(a) Load-deflection curve ,(b) Lintel-Masonry Test Wall 4-Foot Span (6Layer Masonry) under concentrated loading.

6.9 Lintel-Masonry Test Wall 6-Foot Span (8 Layer Masonry)

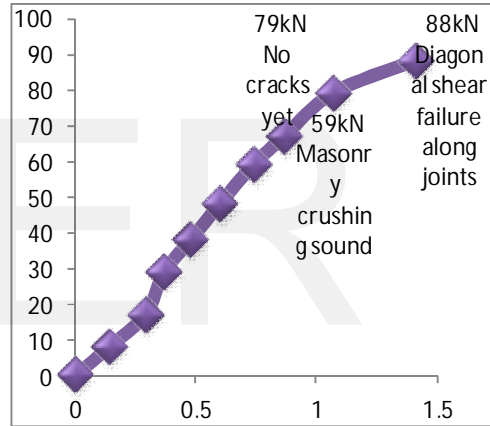
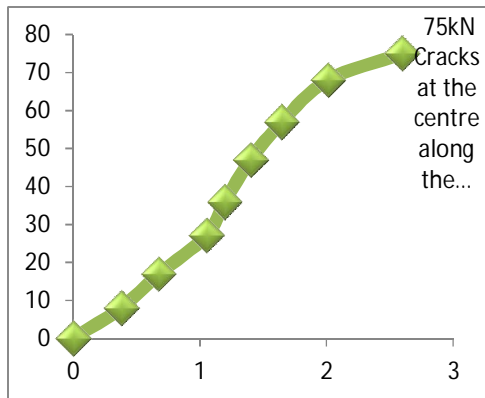

Figure 6.5.(a) Load-deflection curve ,(b) Lintel-Masonry Test Wall 6-Foot Span (8Layer Masonry) under concentrated loading.

6.8 Lintel-Masonry Test Wall 4-Foot Span (8layer Masonry):



6.10 Lintel-Masonry Test Wall 6-Foot Span(8layerMasonry):

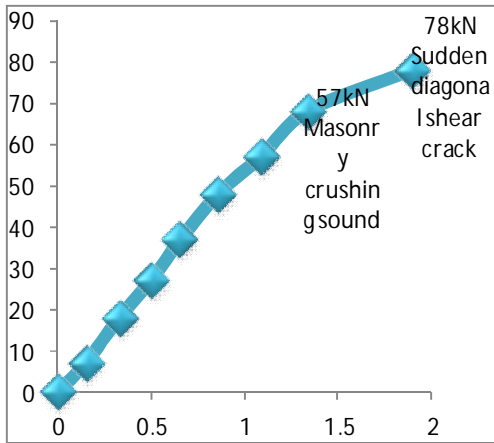

Figure 6.6.(a) Load-deflection curve ,(b) Lintel-Masonry Test Wall 6-Foot Span (8Layer Masonry) under concentrated loading.

During the testing of the specimens under concentrated load at mid span it was observed that the RCC lintel fails in bending while the lintel-masonry panels majorly fail in shear along the diagonal shear crack.

As the height of the masonry above the lintel increases the load at failure also increases and the mode of failure changes from the shear-flexural cracks at mid span to deep diagonal shear cracks extending up to the support. The failure in all the specimens is found to be propagating from the point of loading to the supports along the joints of masonry bond. The bearing capacities of the lintels are highly enhanced due to the masonry above due to the arching action developed between the beam and the masonry. There is concentration of stress at the supports while the middle portion of the lintel is relieved of the vertically acting load.

7. ANALYSIS:

The specimens were analysed as linearly elastic composite sections. The neutral axis is assumed to pass

through the centre of gravity of the section and the stress distribution for the masonry is considered to be linear. The ultimate moment capacity is calculated by applying the two simple equations of static equilibrium.

7.1 FLEXURAL ANALYSIS:

7.1.1 Ultimate Moment Capacity Of Specimen 1 – RCC Lintel: By Is 456:2000.

Since it is an over reinforced section concrete fails prior to yielding of steel, the ultimate moment capacity of the lintel was calculated to be:

$$M_{Utheoretical} = 2.19 \text{ kNm}$$

7.1.2 Ultimate Moment Capacity of Lintel-Masonry Panels:

The ultimate moment capacity is calculated by applying the two simple equations of static equilibrium:

$$C = T \tag{1}$$

$$M = Cz = 0.5Xbf_c Z$$

$$M = Tz = A_{st} f_{st} Z$$

Where,

- X is neutral axis dept,
- b is width of specimen,
- fc is compressive strength of masonry,
- Z is lever arm,
- Ast is the area of steel provided,
- fst is the tensile strength of steel provided.

Table 7.1 Moment capacity of specimens.

Specimen	Mu experimental (N/mm ²)	Mu theoretical (IS Code) (N/mm ²)	Mu theoretical / Mu experimental
1	5.86	2.19	0.37
2	16.5	13.5	0.90
3	18.12	34.6	1.90
4	19.98	65.9	3.30
5	36.96	65.9	1.80
6	33.18	65.9	1.98

7.2 SHEAR ANALYSIS:

7.2.1 Shear Strength of RCC Lintel: By IS 456:2000.

$$\tau = \frac{V}{bd} \tag{2}$$

$$V = V_c + V_s \tag{3}$$

$$V_c = \tau_c bd \tag{4}$$

$$\tau_c = 0.82N \frac{N}{mm^2}$$

taken from table 19 IS 456: 2000.

$$V_s = \frac{0.87 f_y A_{sv} d}{s_v} = 6.8 \text{ kN}$$

Therefore,

$$\tau = 1.53 \text{ N/mm}^2$$

7.2.2 Shear Strength Of Lintel- Masonry Panels:

The shear strength of the lintel-wall panels were analysed assuming that the specimens behave as a deep beam. Thus the shear capacity of the lintel-wall panels were calculated by the British code provisions as well as the IS code provisions.

Shear Capacity by British Code:

The British practice requires numerical calculations for design of deep beams for shear. The design is based on the results of research carried out by Kong and others. It is applicable only to simply supported beams of span depth ratios not exceeding two. The shear analysis is carried out by assuming a structural idealisation of critical diagonal tension failure line along the natural load path which in case of concentrated loads is taken as the line joining the load and the support as shown in the figure.

$$\tau = \frac{V}{bd}$$

$$V = V_c + V_s$$

V_c and V_s is the shear that can be carried by concrete and steel respectively.

$$V_c = C(1 - 0.35 \frac{a}{D}) f_t t D \quad (5)$$

Where C = a coefficient equal to 0.72 for normal weight concrete,

a/D = shear span/ depth ratio,

f_t = flexural tensile strength of bricks on flat.

The formula given above is modified by considering the flexural tensile strength of bricks on flat instead of the splitting tensile strength of concrete cylinders as in this case the brick masonry is analysed as a deep beam. Ignoring the shear carried by steel as there has been no reinforcement provided in the masonry deep beam.

Shear Capacity by Indian Code: IS 456:2000

The design shear strength of concrete in reinforced concrete beams without shear reinforcement is limited to the value of the nominal shear stress corresponding to the load at which the first inclined crack develops.

The magnitude of the design shear strength depends on various factors that are related to the grade of concrete and the percentage of tension steel. The following empirical formula is used to calculate the shear strength of the lintel – masonry panels considering the absence of

any shear reinforcement in the masonry and assuming the compressive strength of masonry:

$$\tau_c = \frac{0.85 \sqrt{0.8 f_{ck}} (\sqrt{1 + 5\beta})}{6\beta} \quad (6)$$

Where,

$$\beta = \frac{0.8 f_{ck}}{6.89 P_t} \quad (7)$$

or 1,

Whichever is greater.

where,

$$\frac{P_t}{100} = \frac{A_{st}}{bd}$$

f_{ck} = compressive strength of masonry.

In the equations 6 and 7 the value of f_{ck} is considered as the compressive strength of brick masonry instead of the characteristic compressive strength of concrete. This modification is employed analogous to the practical composition of specimens in the experiments is deep beams of brick masonry.

The compressive strength of masonry as observed by researchers was found to be smaller than the nominal compressive strength of the units as given by a standard compressive test. Finally, it has been shown by Hendry et.al. [11] that the compressive strength of masonry varies roughly as the square root of the nominal unit crushing strength and as the third or fourth root of the mortar cube strength.

The following formula is given for masonry strengths, relating unit and mortar strengths to masonry characteristic strength as follows:

$$f = K f_b^{0.65} f_m^{0.25} \text{ N/mm}^2 \quad (8)$$

Where, f is masonry strength,

f_b is unit compressive strength,

f_m is the specified compressive strength of mortar

and

K is a constant depending on construction ranging from 0.6 to 0.4.

Table 7.2 Shear capacity of Specimens.

specimen	τ_{exper}	τ_{theoret}	τ_{theoret}	τ_{theoret}	$\tau_{\text{theoretical}}$
	(N/mm ²)	(British code) (N/m ²)	(IS code) (N/m ²)	(British Code)	(IS Code)
1	1.14	1.52	1.52	1.3	1.33
2	0.36	0.90	0.26	2.5	0.72
3	0.23	1.19	0.22	5.2	0.95
4	0.19	1.36	0.23	7.2	1.20
5	0.22	1.12	0.23	5.1	1.05
6	0.20	1.12	0.23	5.6	1.10

From the shear analysis based on the equation adopted by the British code in comparison with the equation given by the Indian code it was found that the theoretical results agree with the experimental results by the later.

8. CONCLUSION

Masonry wall carrying load on the top and resting on a beam spanning over an opening serves not only as a load transferring media but also acts as a composite part of the supporting beam. The composite action of the wall with the supporting beam produces arching action. The compression of the arch is mostly contained in the masonry wall, while the supporting beams being acted upon mostly by tension.

Thus a major portion of the super imposed load concentrates towards the support providing a great relief of load on the beam at the mid span. This results in a considerable reduction of bending moment in the beam. It is the most important contribution of composite action of the wall- beam structure.

From the study it was observed that as the height of masonry above the supporting lintel beam increased the ultimate load carried by the structure also increased greatly. Evidently it can be deduced that the masonry is playing a major role in transferring the load acted upon the composite structure.

The ultimate moment capacity of the specimens is calculated by applying the equations of static equilibrium in the structure, and it is found that there is huge amount of reduction in the mid-span moment of the lintel-wall panels due to the affect of arching action as observed by the previous researchers.

The shear strength of the specimens were analysed by two different methods adopted from the British codes considering the shear span-depth ratio assuming the conditions of deep beams and by the Indian codes by taking the percentage of steel into account for the section.

It is found that the experimental results agree with the theoretical results given by method adopted by the Indian codes.

In all the specimens tested to failure in flexure the supporting lintel does not fail but only the masonry fails in shear and at the interface of the wall-beam of the composite structure. Thereby, the consumption of concrete and reinforcement for such structural element can be substantially reduced if composite action between the masonry wall and the supporting beam is considered

REFERENCES:

- [1] Jaisingh M.P., Jaisingh Lathika, Jain S K., " *Building Research Note-30*" 1981, Central Building Research Institute Roorkee (U.P.), January.
- [2] Beall Christine, " *Lintel Design and Detailing*", National Concrete Masonry Association, Herndon, 1993.
- [3] Vermeltfoort A.T. & Schijndel A. W. M, " *Modelling of Lintel-Masonry Interaction Using COMSOL*", Eindhoven University of Technology, 2008.
- [4] U.S. Department of Housing and Urban Development, Office of Policy Development and Research, NAHB Research Center , " *Lintel Testing for Reduced Shear Reinforcement in Insulating Concrete Form Systems*", Washington DC, May 1998.
- [5] Shetty M.S., " *Concrete Technology*", S.Chand publication, 1982.
- [6] Punmia B.C., Jain Ashok kumar, Jain Arun Kumar, " *Building Construction*", Laxmi Pulications Pvt. Ltd., 1984.
- [7] Coull Alexander and Wong Yang Chee, " *Composite Action between Slabs and Lintel Beams*", Journal of Structural Engineering, 1984, 110:575-588.
- [8] Mohammad Rashid and Ahsanul Kabir, " *Behaviour of Reinforced Concrete Deep beams*", Journal of Civil Engineering, The Institution of Engineers, Bangladesh, Vol CE 24, No. 2 1996.
- [9] H. A. R. dePaiva and W. J. Austin, " *Behaviour and Design of Deep Structural Members (Part 3) tests of Reinforced Concrete Deep Beams*", University Of Illinois, Civil Engineering Studies, Structural Research Series No. 194, March 1960.
- [10] Hossain Monjur, Ali Sekender and Rahman Azadur, " *Studies in Wall-Beam Composite Structures: An Elastic Approach*", Journal of Civil Engineering, The Institution of Engineers, Bangladesh, Vol. CE 25, No.2, 1997.
- [11] Professor F.K.Kong, " *Reinforced Concrete Deep Beams*", Taylor & Francis e-Library, New York, 2002.
- [12] A.W.Hendry, B.P.Sinha and S.R.Davies, " *Design Of Masonry Structures*", Department of Civil Engineering, University of Edinburgh, UK, ISBN 0-203-37498-3, 1997.
- [13] IS 1077:1992, " *Indian Standard, Common Burnt Clay Building Bricks - Specification*", New Delhi.
- [14] IS 2212: 1991, " *Indian Standard, Brick Works-Code Of Practice*", New Delhi.
- [15] IS 3495 (Parts 1 to 4): 1992, " *Indian Standard Methods of Tests of Burnt Clay Building Bricks*", Bureau of Indian Standards, New Delhi.
- [16] SP 20:1991, " *Handbook on masonry construction and design*", Bureau of Indian Standards, New Delhi.
- [17] IS 1905: 1987, " *Code Of Practice For Structural Use Of Unreinforced Masonry*", Bureau of Indian Standards, New Delhi.
- [18] IS 456:2000, " *Indian Standard Plain and Reinforced Concrete- Code of Practice*", Bureau of Indian Standards, New Delhi.